

ROLLER FOLLOWERS

- Separable Roller Followers
- Non-separable Roller Followers
- C-Lube Roller Followers
- Cylindrical Roller Followers

High carbon steel made
Stainless steel made



Structure and Features

IKO Roller Followers are bearings designed for outer ring rotation, in which needle rollers are incorporated in a thick walled outer ring. Both crowned and cylindrical outer rings are available. The outer rings run directly on mating cam guide surfaces, and the crowned outer ring is effective in relieving the edge load caused by mounting errors. The cylindrical outer ring, on the other hand, has a large contact area with the mating cam guide surface and is suitable for applications involving large loads or low cam guide surface hardness.

In Roller Followers, there are two types of bearings available, the caged type and the full complement type. The caged type is useful for applications at high-speed rotation. The full complement type, on the other hand, is suitable for heavy-load applications at low-speed rotation or oscillating motions.

Roller Followers include separable and non-separable types. Also, in addition to the open type, shield type and sealed type are available. The clearances between the side plates and outer ring of the shield type are narrow, and form labyrinths. In the sealed type, special synthetic rubber seals are assembled in these clearances, and they are effective in preventing penetration of dust and dirt.

These bearings are available in a variety of types to suit almost any kind of application. They are widely used for cam mechanisms and for linear motions of conveying equipment.

Structures of Roller Followers

Structure of Separable Roller Follower

NAST...R

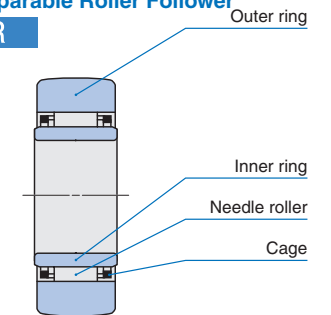

Structure of Separable Roller Follower

NAST...ZZ

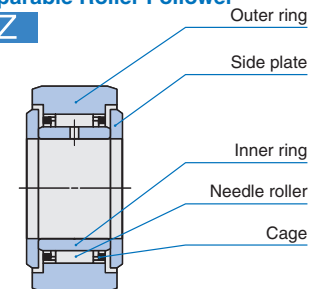

Structure of Non-separable Roller Follower

NART...VUUR

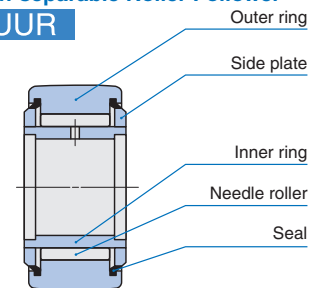

Structure of Cylindrical Roller Follower

NURT...R

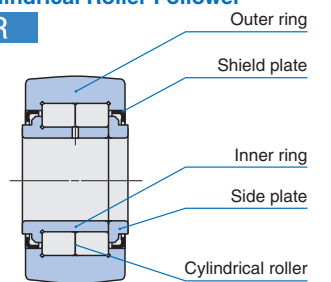

Types

In Roller Followers, types shown in Table 1 are available.

Table 1 Type of Roller Followers

Type				With cage		Full complement type	
				Crowned outer ring	Cylindrical outer ring	Crowned outer ring	Cylindrical outer ring
Metric series	Separable Roller Followers RNAS ^t , NAST	Without inner ring	Open type	RNAS ^t ... R	RNAS ^t	—	—
		With inner ring	Open type	NAS ^t ... R	NAS ^t	—	—
			Shield type	NAS ^t ... ZZ R	NAS ^t ... ZZ	—	—
			Sealed type	NAS ^t ... ZZUUR	NAS ^t ... ZZUU	—	—
	Non-separable Roller Followers NART	High carbon steel made	Shield type	NART ... R	—	NART ... V R	—
			Sealed type	NART ... UU R	—	NART ... VUUR	—
		Stainless steel made	Shield type	NART ... F R	—	—	—
			Sealed type	NART ... FUUR	—	—	—
	C-Lube Roller Followers NART ... /SG		Sealed type	NART ... UUR/SG	—	—	—
	Cylindrical Roller Followers NURT		Shield type	—	—	NURT ... R	NURT
Inch series	Non-separable Roller Followers CRY		Shield type	—	—	CRY ... V R	CRY ... V
			Sealed type	—	—	CRY ... VUUR	CRY ... VUU

Separable Roller Followers

These bearings are assembled by combining an outer ring, inner ring and Needle Roller Cage, which can be separated from one another. Thus, handling is easy. Oil lubrication is also easy, making them suitable for high-speed rotations.

There are two types: type without inner ring RNAS^t and type with inner ring NAS^t. The type with inner ring includes open type, shield type, and sealed type.

Non-separable Roller Followers

These non-separable type bearings have side plates fixed on both sides of the inner ring, and include the caged type and the full complement type. Both shield type and sealed type are available. As well, these bearings also offer a highly corrosion-resistant stainless steel specification, of which the products are suitable for applications where rust prevention oil is not preferred, such as in cleanroom environments.

Inch series Non-separable Roller Followers are full complement type bearings with black oxide surface treatment.

C-Lube Roller Followers

These Roller Followers are lubricated with C-Lube, an IKO original thermosetting solid-type lubricant which fills the inner space of the bearing. C-Lube is lubricant made of a lot of lubricant and fine particles of super-high molecular polyolefin that are solidified by heat treatment. As the bearing rotates, the lubricant oozes out onto the raceway in proper quantities, maintaining the lubrication performance for a long period of time.

Cylindrical Roller Followers

These bearings are full complement type bearings incorporating double rows of full complement cylindrical rollers in the outer ring, and can withstand large radial loads.

Additionally, the outer ring is guided by the outer ring shoulder and the end face of cylindrical rollers to the axial direction.

Identification Number

Some examples of the identification number of Roller Followers are shown below.

Examples of identification number

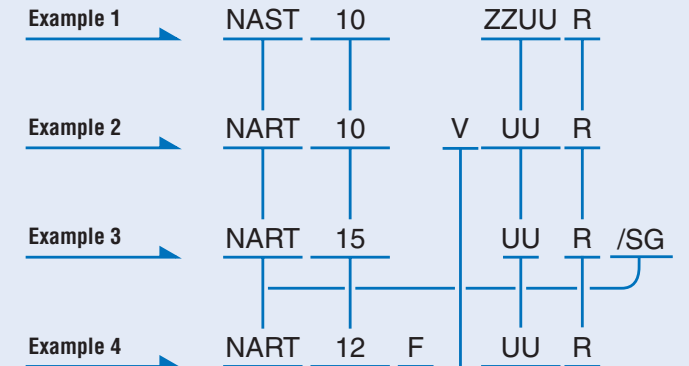

Model code		
Metric series	RNAS ^t	Separable Roller Follower Without inner ring
	NAS ^t	Separable Roller Follower With inner ring
	NART	Non-separable Roller Follower
	NART ... /SG	C-Lube Roller Follower
Inch series	NURT	Cylindrical Roller Follower
	CRY	Non-separable Roller Follower

Size	
The size indicates the bore diameter of the inner ring. (unit: mm)	
In the inch series, the outer diameter of the outer ring is indicated in units of 1/16 inch.	

Type of material	
No symbol	High carbon steel made
F ⁽¹⁾	Stainless steel made

Roller guide method	
No symbol	With cage
V	Full complement type

Seal structure (Separable Roller Follower)	
No symbol	Open type
ZZ	Shield type
ZZUU	Sealed type

Seal structure (Other Roller Follower)	
No symbol	Shield type
UU	Sealed type

Shape of outer ring outside surface	
R	With crowned outer ring
No symbol	With cylindrical outer ring

Note⁽¹⁾ Applicable to Non-separable Roller Followers only

I
NAST
NART
NURT
CRY

Accuracy

Dimensional accuracy and rotational accuracy of Roller Followers are based on Tables 2, 3 and 4. Tolerances for the smallest single roller set bore diameter of Separable Roller Followers are shown in Table 5. Roller Followers with special accuracy can also be manufactured. Please contact IKO.

Table 2 Tolerances

unit: μ m

Dimensions and symbols	Series	Metric series		Inch series	
		Crowned outer ring	Cylindrical outer ring	Crowned outer ring	Cylindrical outer ring
Bore dia. of inner ring d	$d \leq 19.05$	See Table 3.		+ 5 - 10	+ 5
	$19.05 < d$	See Table 3.		+ 2 - 12	- 10
Outside dia. of outer ring D		0 - 50	See Table 4.	0 - 50	0 - 25
Width of outer ring C		0 - 120		0 - 130	
Width of inner ring B	Separable Roller Follower	0 - 120		-	
Width of bearing B	Non-separable Roller Follower	h12	-	+ 130	
	Cylindrical Roller Follower		h12	- 250	
Roller set bore dia. F_w	Separable Roller Follower	See Table 5.		-	

Table 3 Tolerances and allowable values of inner rings (Metric series)

unit: μ m

d Nominal bore dia. mm		Δ_{dmp} Single plane mean bore dia. deviation		V_{dp} ⁽¹⁾ Bore dia. variation in a single radial plane	V_{dmp} ⁽¹⁾ Mean bore dia. variation	K_{ia} ⁽¹⁾ Radial runout of assembled bearing inner ring	V_{Bs} Width variation
Over	Incl.	High	Low	(Max.)	(Max.)	(Max.)	(Max.)
2.5	10	0	- 8	10	6	10	15
10	18	0	- 8	10	6	10	20
18	30	0	- 10	13	8	13	20
30	50	0	- 12	15	9	15	20

Table 4 Tolerances and allowable values of outer rings (Metric series)

unit: μ m

D Nominal outside dia. of outer ring mm		Δ_{Dmp} Single plane mean outside dia. deviation		V_{Dp} ⁽¹⁾ Outside dia. variation in a single radial plane	V_{Dmp} ⁽¹⁾ Mean outside dia. variation	K_{ea} ⁽¹⁾ Radial runout of assembled bearing outer ring	V_{Cs} Width variation
Over	Incl.	High	Low	(Max.)	(Max.)	(Max.)	(Max.)
6	18	0	- 8	10	6	15	Same as the tolerance values of V_{Bs} for d of the inner of the same bearing
18	30	0	- 9	12	7	15	
30	50	0	- 11	14	8	20	
50	80	0	- 13	16	10	25	
80	120	0	- 15	19	11	35	

Note⁽¹⁾ Also applicable to the inch series.

Table 5 Tolerances of smallest single roller set bore diameter $F_{ws \min}$

unit: μ m

F_w Nominal roller set bore diameter mm		$\Delta_{Fws \min}$ Deviation of smallest single roller set bore diameter	
Over	Incl.	High	Low
6	10	+ 22	+ 13
10	18	+ 27	+ 16
18	30	+ 33	+ 20
30	50	+ 41	+ 25
50	80	+ 49	+ 30

Clearance

Radial internal clearances of Roller Followers are based on Table 6.

Table 6 Radial internal clearance

unit: μ m

Identification number ⁽¹⁾				Radial internal clearance	
Metric series			Inch series	Min.	Max.
Separable Roller Followers	Non-separable Roller Followers ⁽²⁾	Cylindrical Roller Followers	Non-separable Roller Followers		
NAST 6R	NART 5R	-	-	5	20
NAST 8R ~ NAST12R	NART 6R ~ NART12R	-	-	5	25
NAST15R ~ NAST25R	NART15R ~ NART20R	-	-	10	30
NAST30R ~ NAST40R	NART25R ~ NART40R	-	-	10	40
NAST45R, NAST50R	NART45R, NART50R	-	-	15	50
-	-	NURT15R ~ NURT30-1R	-	20	45
-	-	NURT35R ~ NURT40-1R	-	25	50
-	-	NURT45R ~ NURT50-1R	-	30	60
-	-	-	CRY12R ~ CRY56R	35	60
-	-	-	CRY64R	45	70

Note⁽¹⁾ Also applicable to the full complement type, cylindrical outer ring type, shield type and sealed type.

⁽²⁾ Also applicable to C-Lube Roller Followers.

Fit

Roller Followers are generally used under the loading conditions in which the load direction is fixed in relation to the inner ring and rotates in relation to the outer ring. The recommended fits for shafts are shown in Table 7. Those for the inch series are shown in the dimension table.

Table 7 Recommended fit (Metric series)

Type	Tolerance class of shaft
Separable Roller Followers	without inner ring: k5, k6 with inner ring: g6, h6
Non-separable Roller Followers ⁽¹⁾	g6, h6
Cylindrical Roller Followers	g6, h6

Note⁽¹⁾ Also applicable to C-Lube Roller Followers.

Maximum allowable static load

The load that is applicable to Roller Followers is, in some cases, determined by the strength of the outer ring rather than by the load rating of the needle roller bearing. Therefore, the maximum allowable load that is limited by the strength of outer ring is specified.

Track Capacity

Track capacity is defined as the load that can be continuously applied on a Roller Follower placed on a steel cam guide surface without causing deformation and indentation on the cam guide surface when the outer ring of the Roller Follower makes contact with the mating cam guide surface (plane). The track capacities shown in Tables 8.1 and 8.2 are applicable when the hardness of the mating cam guide surface is 40HRC

(Tensile strength 1250N/mm²). When the hardness of the mating cam guide surface differs from 40HRC, the track capacity is obtained by multiplying the value by the track capacity factor shown in Table 9.

If lubrication between the outer ring and the mating cam guide surface is insufficient, seizure and/or wear may occur depending on the application. Therefore, pay attention to lubrication and surface roughness of the mating cam guide especially in the case of high-speed rotation such as for cam mechanisms.

Table 8.1 Track capacity (Metric series)

unit: N

Roller Followers with crowned outer ring				Roller Followers with cylindrical outer ring					
Identification number ⁽¹⁾			Track capacity	Identification number	Track capacity	Identification number ⁽²⁾	Track capacity	Identification number	Track capacity
Separable Roller Followers	Non-separable ⁽³⁾ Roller Followers	Cylindrical Roller Followers							
RNAST 5R	NART 5R	—	1 040	RNAST 5	2 310	—	—	—	—
(R)NAST 6R	NART 6R	—	1 330	(R)NAST 6	3 550	NAST 6ZZ	3 550	—	—
(R)NAST 8R	NART 8R	—	1 850	(R)NAST 8	3 980	NAST 8ZZ	4 490	—	—
(R)NAST10R	NART10R	—	2 470	(R)NAST10	5 610	NAST10ZZ	6 890	—	—
(R)NAST12R	NART12R	—	2 710	(R)NAST12	5 990	NAST12ZZ	7 350	—	—
(R)NAST15R	NART15R	—	3 060	(R)NAST15	6 550	NAST15ZZ	8 030	NURT15	11 500
—	—	NURT15-1R	3 910	—	—	—	—	NURT15-1	13 700
(R)NAST17R	NART17R	—	3 660	(R)NAST17	10 900	NAST17ZZ	11 700	NURT17	13 600
—	—	NURT17-1R	4 530	—	—	—	—	NURT17-1	16 000
(R)NAST20R	NART20R	—	4 530	(R)NAST20	12 800	NAST20ZZ	13 800	NURT20	20 000
—	—	NURT20-1R	5 190	—	—	—	—	NURT20-1	22 100
(R)NAST25R	NART25R	—	5 190	(R)NAST25	14 100	NAST25ZZ	15 300	NURT25	22 100
—	—	NURT25-1R	6 580	—	—	—	—	NURT25-1	26 400
(R)NAST30R	NART30R	—	6 580	(R)NAST30	22 100	NAST30ZZ	22 100	NURT30	31 600
—	—	NURT30-1R	8 020	—	—	—	—	NURT30-1	36 700
(R)NAST35R	NART35R	—	8 020	(R)NAST35	25 700	NAST35ZZ	25 700	NURT35	36 700
—	—	NURT35-1R	9 220	—	—	—	—	NURT35-1	40 800
(R)NAST40R	NART40R	—	9 220	(R)NAST40	26 900	NAST40ZZ	30 300	NURT40	44 200
—	—	NURT40-1R	10 800	—	—	—	—	NURT40-1	49 700
(R)NAST45R	NART45R	—	9 990	(R)NAST45	28 500	NAST45ZZ	32 200	NURT45	47 000
—	—	NURT45-1R	12 400	—	—	—	—	NURT45-1	55 300
(R)NAST50R	NART50R	—	10 800	(R)NAST50	30 200	NAST50ZZ	34 000	NURT50	49 700
—	—	NURT50-1R	14 000	—	—	—	—	NURT50-1	60 800

Notes⁽¹⁾ Also applicable to the full complement type, shield type, and sealed type. ⁽²⁾ Also applicable to C-Lube Roller Followers. ⁽³⁾ Also applicable to the sealed type.

Table 8.2 Track capacity (Inch series)

unit: N

Crowned outer ring		Cylindrical outer ring	
Identification number ⁽¹⁾	Track capacity	Identification number ⁽¹⁾	Track capacity
CRY12R	853	CRY12	4 490
CRY14R	1 050	CRY14	5 240
CRY16R	1 420	CRY16	7 270
CRY18R	1 660	CRY18	7 700
CRY20R	2 160	CRY20	10 700
CRY22R	2 450	CRY22	11 800
CRY24R	3 410	CRY24	15 400
CRY26R	3 820	CRY26	16 700
CRY28R	4 210	CRY28	21 000
CRY30R	4 610	CRY30	22 500
CRY32R	5 690	CRY32	30 800
CRY36R	6 640	CRY36	34 700
CRY40R	8 970	CRY40	44 900
CRY44R	10 200	CRY44	49 400
CRY48R	11 400	CRY48	64 300
CRY52R	12 700	CRY52	69 600
CRY56R	14 100	CRY56	87 000
CRY64R	16 800	CRY64	113 000

Note⁽¹⁾ Also applicable to the sealed type.

Table 9 Track capacity factor

Hardness HRC	Tensile strength N/mm ²	Track capacity factor	
		Crowned outer ring	Cylindrical outer ring
20	760	0.22	0.37
25	840	0.31	0.46
30	950	0.45	0.58
35	1 080	0.65	0.75
38	1 180	0.85	0.89
40	1 250	1.00	1.00
42	1 340	1.23	1.15
44	1 435	1.52	1.32
46	1 530	1.85	1.51
48	1 635	2.27	1.73
50	1 760	2.80	1.99
52	1 880	3.46	2.29
54	2 015	4.21	2.61
56	2 150	5.13	2.97
58	2 290	6.26	3.39

Allowable Rotational Speed

The allowable rotational speed of Roller Followers is affected by mounting and operating conditions. For *dn* value with only pure radial load applied, use values in Table 10 or less as a guideline.

Considering that axial loads also act under actual operating conditions, the recommended *dn* value is 1/10 of the value shown in the table.

For use with oscillating rotation, use a C-Lube Roller Follower *dn* value of 8,000 or less as a guideline. For use with one-way or continuous rotation, please consult IKO.

Table 10 *dn* values of Roller Followers⁽¹⁾

Type	Lubricant	
	Grease	Oil
Caged type	84 000	140 000
Full complement type	42 000	70 000
Cylindrical Roller Follower	72 000	120 000

Note⁽¹⁾ dn value = $d \times n$
 where, d : Bore diameter of bearing mm
 n : Rotational speed min⁻¹

Lubrication

In Sealed Type Roller Followers, Heavy Duty Type Roller Followers and Inch series Roller Followers, ALVANIA GREASE S2 (Shell Lubricants Japan K.K.) is prepacked as the lubricating grease.

For Roller Followers without prepacked grease, grease or oil should be supplied through the oil hole of the inner ring for use. If they are used without lubrication, wear of rolling contact surfaces may take place, leading to a short bearing life.

Oil Hole

Open Type Separable Roller Followers have no oil hole. Inner rings of other types of Metric series Roller Followers have an oil hole. Inch series inner rings have an oil groove and an oil hole.

Mounting

- In case of shield and sealed types, match the side surface correctly to the mating seating surface indicated by the dimension *a* shown in the dimension table, and fix them. (See Fig. 1.)
- When mounting Roller Followers, pay special attention to avoid locating the oil hole of the inner ring within the loading zone. This may lead to a short bearing life. (See Fig. 2.)
- When mounting Sealed Type Separable Roller Followers, do not cause the side plates to come off. If they come off, set them again in place taking care to avoid damaging the seal lips.

④ In case of Roller Followers without an inner ring, the shaft requires heat treatment and grinding finish. The recommended surface hardness of the shaft is 58 ~ 64HRC, and the recommended roughness of the shaft is 0.2 μmR_a or less.

Also, the outer ring and cage are guided by side surfaces of the mounting parts. Therefore, it is recommended that the side surfaces of the mounting parts be finished by grinding or at least by machining. (See Fig. 3.)

⑤ In Non-separable Roller Followers, the side plates are press-fitted. Therefore, when mounting the Roller Followers, do not push the side plates/outer rings.

Pushing on the side plates or outer rings may cause unsatisfactory product performance.

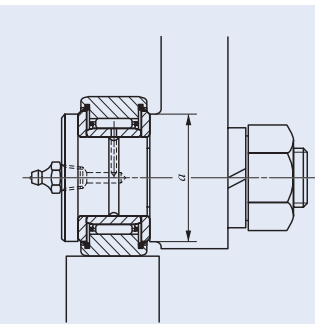

Fig. 1 Mating seating dimension "a"

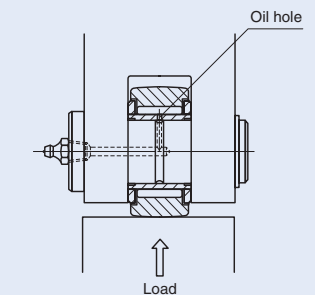

Fig. 2 Position of oil hole and load direction

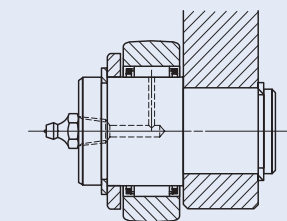
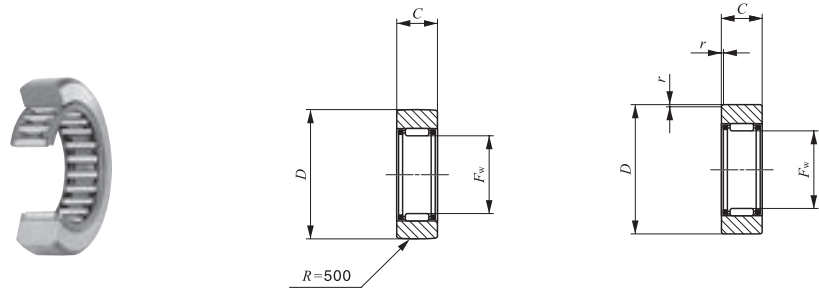

Fig. 3 Mounting example of Roller Follower without inner ring

1N=0.102kgf=0.2248lbs.
 1mm=0.03937inch

Separable Roller Followers, Open Type **With Cage/Without Inner Ring**



Shaft dia. 7 – 60mm

RNAS...R

RNAS

Shaft dia. mm	Identification number		Mass (Ref.) g	Boundary dimensions mm				Basic dynamic load rating C N	Basic static load rating C ₀ N
	Open type			F _w	D	C	r _{s min} ⁽¹⁾		
	Crowned outer ring	Cylindrical outer ring							
7	RNAS 5 R	RNAS 5	8.9	7	16	7.8	0.3	2 710	2 390
10	RNAS 6 R	RNAS 6	13.9	10	19	9.8	0.3	4 160	4 550
12	RNAS 8 R	RNAS 8	23.5	12	24	9.8	0.6	5 650	5 890
14	RNAS 10 R	RNAS 10	42.5	14	30	11.8	1	9 790	9 680
16	RNAS 12 R	RNAS 12	49.5	16	32	11.8	1	10 500	10 900
20	RNAS 15 R	RNAS 15	50	20	35	11.8	1	12 400	14 300
22	RNAS 17 R	RNAS 17	90	22	40	15.8	1	17 600	20 900
25	RNAS 20 R	RNAS 20	135	25	47	15.8	1	19 400	24 500
30	RNAS 25 R	RNAS 25	152	30	52	15.8	1	20 800	28 400
38	RNAS 30 R	RNAS 30	255	38	62	19.8	1	30 500	45 400
42	RNAS 35 R	RNAS 35	375	42	72	19.8	1	32 400	50 600
50	RNAS 40 R	RNAS 40	420	50	80	19.8	1.5	35 900	61 100
55	RNAS 45 R	RNAS 45	460	55	85	19.8	1.5	37 400	66 400
60	RNAS 50 R	RNAS 50	500	60	90	19.8	1.5	38 900	71 700

Note⁽¹⁾ Minimum allowable value of chamfer dimension *r*

Remarks1. No oil hole is provided.

2. Not provided with prepacked grease. Perform proper lubrication for use.

Separable Roller Followers, Open Type **With Cage/With Inner Ring**

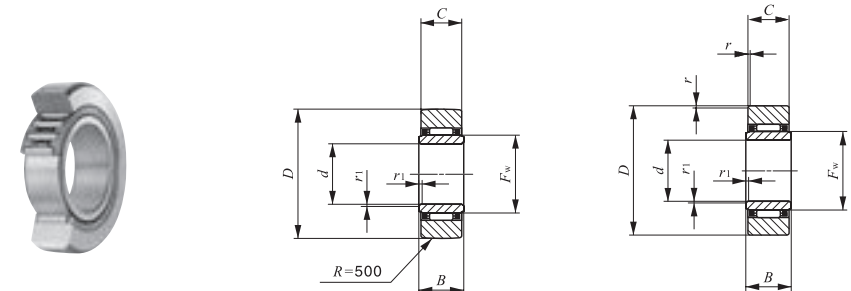

Shaft dia. 6 – 50mm

NAS...R

NAS

Shaft dia. mm	Identification number		Mass (Ref.) g	Boundary dimensions mm						Basic dynamic load rating C N	Basic static load rating C ₀ N	Assembled inner ring	
	Open type			d	D	B	C	r _{s min} ⁽¹⁾	r _{1s min} ⁽¹⁾				F _w
	Crowned outer ring	Cylindrical outer ring											
6	NAS 6 R	NAS 6	17.8	6	19	10	9.8	0.3	0.3	10	4 160	4 550	LRT 61010 S
8	NAS 8 R	NAS 8	28	8	24	10	9.8	0.6	0.3	12	5 650	5 890	LRT 81210 S
10	NAS 10 R	NAS 10	49.5	10	30	12	11.8	1	0.3	14	9 790	9 680	LRT 101412 S
12	NAS 12 R	NAS 12	58	12	32	12	11.8	1	0.3	16	10 500	10 900	LRT 121612 S
15	NAS 15 R	NAS 15	62	15	35	12	11.8	1	0.3	20	12 400	14 300	LRT 152012 S
17	NAS 17 R	NAS 17	109	17	40	16	15.8	1	0.3	22	17 600	20 900	LRT 172216 S
20	NAS 20 R	NAS 20	157	20	47	16	15.8	1	0.3	25	19 400	24 500	LRT 202516 S
25	NAS 25 R	NAS 25	180	25	52	16	15.8	1	0.3	30	20 800	28 400	LRT 253016 S
30	NAS 30 R	NAS 30	320	30	62	20	19.8	1	0.6	38	30 500	45 400	LRT 303820 S
35	NAS 35 R	NAS 35	440	35	72	20	19.8	1	0.6	42	32 400	50 600	LRT 354220 S
40	NAS 40 R	NAS 40	530	40	80	20	19.8	1.5	1	50	35 900	61 100	LRT 405020 S
45	NAS 45 R	NAS 45	580	45	85	20	19.8	1.5	1	55	37 400	66 400	LRT 455520 S
50	NAS 50 R	NAS 50	635	50	90	20	19.8	1.5	1	60	38 900	71 700	LRT 506020 S

Note⁽¹⁾ Minimum allowable value of chamfer dimension *r* or *r*₁

Remarks1. No oil hole is provided.

2. Not provided with prepacked grease. Perform proper lubrication for use.

ROLLER FOLLOWERS

Separable Roller Followers, Shield Type **With Cage/With Inner Ring**
 Separable Roller Followers, Sealed Type **With Cage/With Inner Ring**

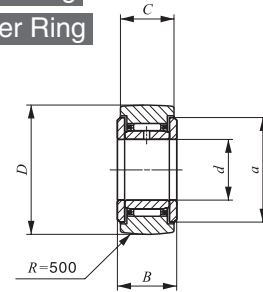

NAST...ZZR

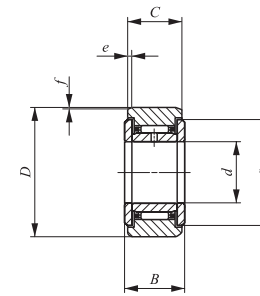

NAST...ZZ

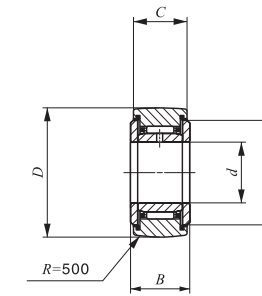

NAST...ZZUUR

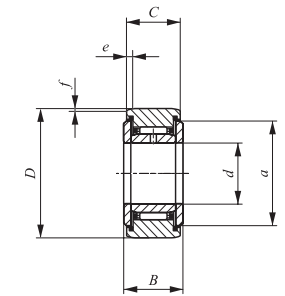

NAST...ZZUU

Shaft dia. 6 – 50mm

Shaft dia. mm	Identification number				Mass (Ref.) g
	Shield type		Sealed type		
	Crowned outer ring	Cylindrical outer ring	Crowned outer ring	Cylindrical outer ring	
6	NAST 6 ZZR	NAST 6 ZZ	NAST 6 ZZUUR	NAST 6 ZZUU	24.5
8	NAST 8 ZZR	NAST 8 ZZ	NAST 8 ZZUUR	NAST 8 ZZUU	39
10	NAST 10 ZZR	NAST 10 ZZ	NAST 10 ZZUUR	NAST 10 ZZUU	65
12	NAST 12 ZZR	NAST 12 ZZ	NAST 12 ZZUUR	NAST 12 ZZUU	75
15	NAST 15 ZZR	NAST 15 ZZ	NAST 15 ZZUUR	NAST 15 ZZUU	83
17	NAST 17 ZZR	NAST 17 ZZ	NAST 17 ZZUUR	NAST 17 ZZUU	135
20	NAST 20 ZZR	NAST 20 ZZ	NAST 20 ZZUUR	NAST 20 ZZUU	195
25	NAST 25 ZZR	NAST 25 ZZ	NAST 25 ZZUUR	NAST 25 ZZUU	225
30	NAST 30 ZZR	NAST 30 ZZ	NAST 30 ZZUUR	NAST 30 ZZUU	400
35	NAST 35 ZZR	NAST 35 ZZ	NAST 35 ZZUUR	NAST 35 ZZUU	550
40	NAST 40 ZZR	NAST 40 ZZ	NAST 40 ZZUUR	NAST 40 ZZUU	710
45	NAST 45 ZZR	NAST 45 ZZ	NAST 45 ZZUUR	NAST 45 ZZUU	760
50	NAST 50 ZZR	NAST 50 ZZ	NAST 50 ZZUUR	NAST 50 ZZUU	830

Remarks1. The inner ring has an oil hole.
 2. The sealed type is provided with prepacked grease. The shield type is not provided with prepacked grease. Perform proper lubrication for use.

Boundary dimensions mm							Basic dynamic load rating C N	Basic static load rating C ₀ N
d	D	B	C	a	e	f		
6	19	14	13.8	14	2.5	0.8	4 160	4 550
8	24	14	13.8	17.5	2.5	0.8	5 650	5 890
10	30	16	15.8	23.5	2.5	0.8	9 790	9 680
12	32	16	15.8	25.5	2.5	0.8	10 500	10 900
15	35	16	15.8	29	2.5	0.8	12 400	14 300
17	40	20	19.8	32.5	3	1	17 600	20 900
20	47	20	19.8	38	3	1	19 400	24 500
25	52	20	19.8	43	3	1	20 800	28 400
30	62	25	24.8	50.5	4	1.2	30 500	45 400
35	72	25	24.8	53.5	4	1.2	32 400	50 600
40	80	26	25.8	61.5	4	1.2	35 900	61 100
45	85	26	25.8	66.5	4	1.2	37 400	66 400
50	90	26	25.8	76	4	1.2	38 900	71 700

I
 NAST
 NURT
 CRY

ROLLER FOLLOWERS

Non-separable Roller Followers · **With Cage/With Inner Ring**

High carbon steel made

Full Complement Type/With Inner Ring

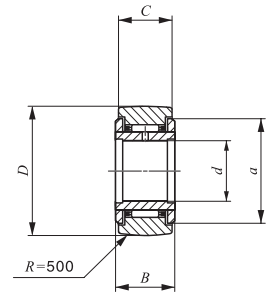

NART...R

Shaft dia. 5 – 40mm

Shaft dia. mm	Identification number				Mass (Ref.) g
	Shield type		Sealed type		
	With cage	Full complement	With cage	Full complement	
5	NART 5 R	—	NART 5 UUR	—	14.5
	—	NART 5 VR	—	NART 5 VUUR	15.1
6	NART 6 R	—	NART 6 UUR	—	20.5
	—	NART 6 VR	—	NART 6 VUUR	21.5
8	NART 8 R	—	NART 8 UUR	—	41.5
	—	NART 8 VR	—	NART 8 VUUR	42.5
10	NART 10 R	—	NART 10 UUR	—	64.5
	—	NART 10 VR	—	NART 10 VUUR	66.5
12	NART 12 R	—	NART 12 UUR	—	71
	—	NART 12 VR	—	NART 12 VUUR	73
15	NART 15 R	—	NART 15 UUR	—	102
	—	NART 15 VR	—	NART 15 VUUR	106
17	NART 17 R	—	NART 17 UUR	—	149
	—	NART 17 VR	—	NART 17 VUUR	155
20	NART 20 R	—	NART 20 UUR	—	250
	—	NART 20 VR	—	NART 20 VUUR	255
25	NART 25 R	—	NART 25 UUR	—	285
	—	NART 25 VR	—	NART 25 VUUR	295
30	NART 30 R	—	NART 30 UUR	—	470
	—	NART 30 VR	—	NART 30 VUUR	485
35	NART 35 R	—	NART 35 UUR	—	640
	—	NART 35 VR	—	NART 35 VUUR	655
40	NART 40 R	—	NART 40 UUR	—	845
	—	NART 40 VR	—	NART 40 VUUR	865

Remarks1. The inner ring has an oil hole.
2. The sealed type is provided with prepacked grease. The shield type is not provided with prepacked grease. Perform proper lubrication for use.

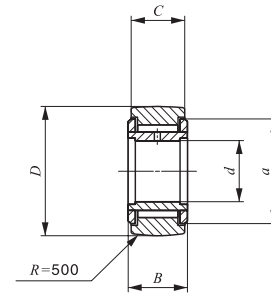

NART...VR

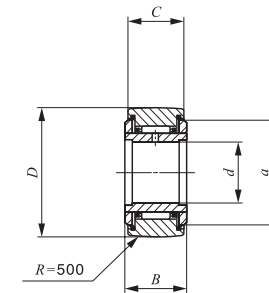

NART...UUR

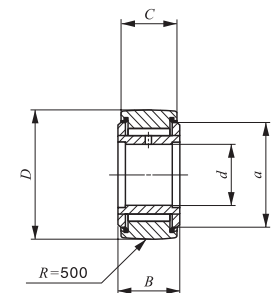

NART...VUUR

Boundary dimensions mm					Basic dynamic load rating C N	Basic static load rating C ₀ N	Maximum allowable static load N
d	D	B	C	a			
5	16	12	11	12	3 650	3 680	3 680
5	16	12	11	12	6 810	8 370	7 310
6	19	12	11	14	4 250	4 740	4 740
6	19	12	11	14	7 690	10 300	10 300
8	24	15	14	17.5	5 640	5 900	5 900
8	24	15	14	17.5	11 800	15 600	15 600
10	30	15	14	23.5	8 030	7 540	7 540
10	30	15	14	23.5	15 600	18 100	17 500
12	32	15	14	25.5	8 580	8 470	8 470
12	32	15	14	25.5	16 800	20 500	18 600
15	35	19	18	29	13 700	16 400	16 400
15	35	19	18	29	25 200	36 400	24 000
17	40	21	20	32.5	17 600	21 000	21 000
17	40	21	20	32.5	32 000	46 300	33 100
20	47	25	24	38	23 000	30 700	30 700
20	47	25	24	38	41 600	67 300	67 300
25	52	25	24	43	24 700	35 400	35 400
25	52	25	24	43	45 500	79 100	79 100
30	62	29	28	50.5	33 600	51 400	51 400
30	62	29	28	50.5	59 900	110 000	92 500
35	72	29	28	53.5	35 700	57 400	57 400
35	72	29	28	53.5	63 100	121 000	121 000
40	80	32	30	61.5	44 900	81 500	81 500
40	80	32	30	61.5	76 300	164 000	164 000

I

NART
NURT
CRY

ROLLER FOLLOWERS

Non-separable Roller Followers · With Cage/With Inner Ring

High carbon steel made Full Complement Type/With Inner Ring

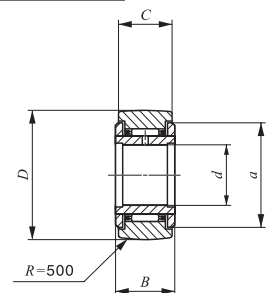

NART...R

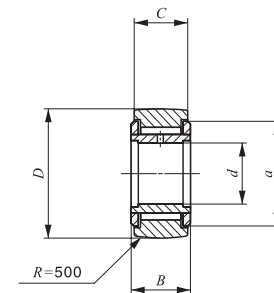

NART...VR

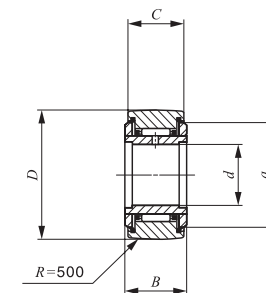

NART...UUR

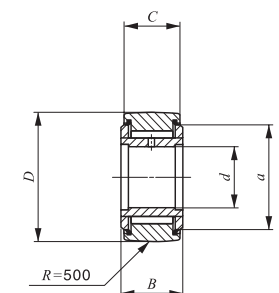

NART...VUUR

Shaft dia. 45 – 50mm

Shaft dia. mm	Identification number				Mass (Ref.) g
	Shield type Crowned outer ring		Sealed type Crowned outer ring		
	With cage	Full complement	With cage	Full complement	
45	NART 45 R	—	NART 45 UUR	—	915
	—	NART 45 VR	—	NART 45 VUUR	935
50	NART 50 R	—	NART 50 UUR	—	980
	—	NART 50 VR	—	NART 50 VUUR	1 010

Remarks1. The inner ring has an oil hole.
2. The sealed type is provided with prepacked grease. The shield type is not provided with prepacked grease. Perform proper lubrication for use.

Boundary dimensions mm					Basic dynamic load rating C N	Basic static load rating C ₀ N	Maximum allowable static load N
d	D	B	C	a			
45	85	32	30	66.5	46 800	88 600	88 600
45	85	32	30	66.5	80 300	181 000	181 000
50	90	32	30	76	48 600	95 600	95 600
50	90	32	30	76	84 300	198 000	198 000

I
NAST
NART
NURT
CRY

Non-separable Roller Followers · Stainless Steel Made **With Cage/With Inner Ring**

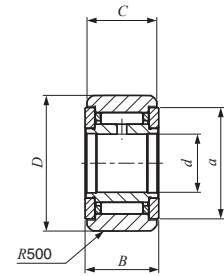

NART...FR

Shaft dia. 5 – 30mm

Shaft dia. mm	Identification number		Mass (Ref.) g	Boundary dimensions mm				
	Shield type	Sealed type		<i>d</i>	<i>D</i>	<i>B</i>	<i>C</i>	<i>a</i>
5	NART 5 FR	NART 5 FUUR	13	5	16	12	11	12
6	NART 6 FR	NART 6 FUUR	19	6	19	12	11	14
8	NART 8 FR	NART 8 FUUR	39	8	24	15	14	17.5
10	NART 10 FR	NART 10 FUUR	61	10	30	15	14	22.5
12	NART 12 FR	NART 12 FUUR	67	12	32	15	14	25.5
15	NART 15 FR	NART 15 FUUR	99	15	35	19	18	27.5
17	NART 17 FR	NART 17 FUUR	146	17	40	21	20	31
20	NART 20 FR	NART 20 FUUR	241	20	47	25	24	36.5
25	NART 25 FR	NART 25 FUUR	269	25	52	25	24	43
30	NART 30 FR	NART 30 FUUR	447	30	62	29	28	50

Remarks1. The inner ring has an oil hole.
2. The sealed type is provided with prepacked grease. The shield type is not provided with prepacked grease. Perform proper lubrication for use.

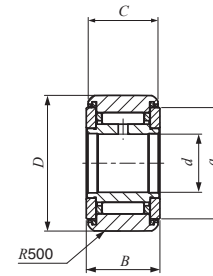

NART...FUUR

Basic dynamic load rating <i>C</i> N	Basic static load rating <i>C</i> ₀ N	Maximum allowable static load N
2 930	2 920	2 920
3 400	3 790	3 790
4 340	5 510	5 510
6 330	7 830	7 830
6 510	8 400	8 400
9 620	14 700	14 700
11 800	20 200	20 200
16 500	27 700	27 700
19 800	28 300	28 300
26 900	41 200	41 200

I
NAST
NART
NURT
CRY

C-Lube Roller Followers **With Cage/With Inner Ring**

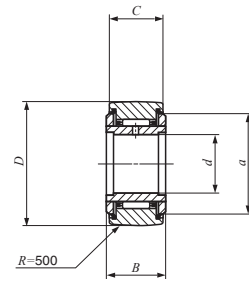

Shaft dia. 5 – 20mm

NART ... UUR/SG

Shaft dia. mm	Identification number Sealed type	Mass (Ref.) g	Boundary dimensions mm				
			<i>d</i>	<i>D</i>	<i>B</i>	<i>C</i>	<i>a</i>
5	NART 5 UUR / SG	14.5	5	16	12	11	12
6	NART 6 UUR / SG	20.5	6	19	12	11	14
8	NART 8 UUR / SG	41.5	8	24	15	14	17.5
10	NART 10 UUR / SG	64.5	10	30	15	14	23.5
12	NART 12 UUR / SG	71	12	32	15	14	25.5
15	NART 15 UUR / SG	102	15	35	19	18	29
17	NART 17 UUR / SG	149	17	40	21	20	32.5
20	NART 20 UUR / SG	250	20	47	25	24	38

Remark This bearing cannot be re-lubricated as thermosetting solid-type lubricant C-Lube fills its inner space.

Basic dynamic load rating <i>C</i> N	Basic static load rating <i>C</i> ₀ N	Maximum allowable static load N
3 650	3 680	3 680
4 250	4 740	4 740
5 640	5 900	5 900
8 030	7 540	7 540
8 580	8 470	8 470
13 700	16 400	16 400
17 600	21 000	21 000
23 000	30 700	30 700

I

NAST
NART
NURT
CRY

ROLLER FOLLOWERS

Cylindrical Roller Followers **Full Complement Type/With Inner Ring**

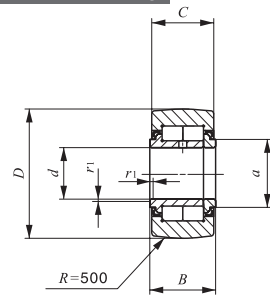
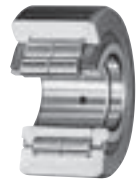

NURT...R

Shaft dia. 15 – 50mm

Shaft dia. mm	Identification number		Mass (Ref.) g	Boundary dimensions mm					
	Crowned outer ring	Cylindrical outer ring		d	D	B	C	a	r _s min ⁽¹⁾
15	NURT 15 R	NURT 15	100	15	35	19	18	20	0.6
	NURT 15-1 R	NURT 15-1	160	15	42	19	18	20	0.6
17	NURT 17 R	NURT 17	147	17	40	21	20	22	1
	NURT 17-1 R	NURT 17-1	222	17	47	21	20	22	1
20	NURT 20 R	NURT 20	245	20	47	25	24	27	1
	NURT 20-1 R	NURT 20-1	321	20	52	25	24	27	1
25	NURT 25 R	NURT 25	281	25	52	25	24	31	1
	NURT 25-1 R	NURT 25-1	450	25	62	25	24	31	1
30	NURT 30 R	NURT 30	466	30	62	29	28	38	1
	NURT 30-1 R	NURT 30-1	697	30	72	29	28	38	1
35	NURT 35 R	NURT 35	630	35	72	29	28	44	1
	NURT 35-1 R	NURT 35-1	840	35	80	29	28	44	1
40	NURT 40 R	NURT 40	817	40	80	32	30	49	1
	NURT 40-1 R	NURT 40-1	1 130	40	90	32	30	49	1
45	NURT 45 R	NURT 45	883	45	85	32	30	53	1
	NURT 45-1 R	NURT 45-1	1 400	45	100	32	30	53	1
50	NURT 50 R	NURT 50	950	50	90	32	30	58	1
	NURT 50-1 R	NURT 50-1	1 690	50	110	32	30	58	1

Note⁽¹⁾ Minimum allowable value of chamfer dimension r or r₁
 Remarks1. The inner ring has an oil hole.
 2. Provided with prepacked grease.

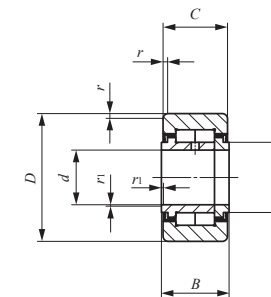

NURT

r _{1s} min ⁽¹⁾	Basic dynamic load rating C	Basic static load rating C ₀	Maximum allowable static load
	N	N	N
0.3	23 400	27 300	11 800
	23 400	27 300	27 300
0.3	25 200	30 900	20 300
	25 200	30 900	30 900
0.3	38 900	49 000	27 200
	38 900	49 000	49 000
0.3	43 100	58 100	30 000
	43 100	58 100	58 100
0.3	58 200	75 300	35 200
	58 200	75 300	75 300
0.6	63 900	88 800	57 000
	63 900	88 800	88 800
0.6	86 500	122 000	75 300
	86 500	122 000	122 000
0.6	91 500	135 000	78 700
	91 500	135 000	135 000
0.6	96 300	148 000	82 100
	96 300	148 000	148 000

I
 NAST
 NURT
 CRY

ROLLER FOLLOWERS

Non-separable Roller Followers, Inch Series **Full Complement Type / With Inner Ring**

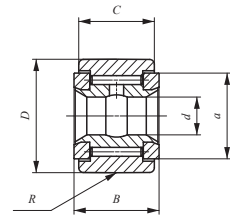

CRY...VR

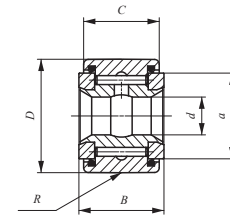

CRY...VUUR

Shaft dia. 6.350 – 31.750mm

Shaft dia. mm (inch)	Identification number		Mass (Ref.) g	Boundary dimensions mm(inch)			
	Shield type Crowned outer ring	Sealed type Crowned outer ring		d	D	B	C
6.350 (1/4)	CRY 12 VR	CRY 12 VUUR	27	6.350 (1/4)	19.050 (3/4)	14.288(0.5625)	12.700 (1/2)
	CRY 14 VR	CRY 14 VUUR	36	6.350 (1/4)	22.225 (7/8)	14.288(0.5625)	12.700 (1/2)
7.938 (5/16)	CRY 16 VR	CRY 16 VUUR	68	7.938 (5/16)	25.400 (1)	17.463(0.6875)	15.875 (5/8)
	CRY 18 VR	CRY 18 VUUR	77	7.938 (5/16)	28.575 (1 1/8)	17.463(0.6875)	15.875 (5/8)
9.525 (3/8)	CRY 20 VR	CRY 20 VUUR	109	9.525 (3/8)	31.750 (1 1/4)	20.638(0.8125)	19.050 (3/4)
	CRY 22 VR	CRY 22 VUUR	136	9.525 (3/8)	34.925 (1 3/8)	20.638(0.8125)	19.050 (3/4)
11.112 (7/16)	CRY 24 VR	CRY 24 VUUR	186	11.112 (7/16)	38.100 (1 1/2)	23.813(0.9375)	22.225 (7/8)
	CRY 26 VR	CRY 26 VUUR	227	11.112 (7/16)	41.275 (1 5/8)	23.813(0.9375)	22.225 (7/8)
12.700 (1/2)	CRY 28 VR	CRY 28 VUUR	290	12.700 (1/2)	44.450 (1 3/4)	26.988(1.0625)	25.400 (1)
	CRY 30 VR	CRY 30 VUUR	363	12.700 (1/2)	47.625 (1 7/8)	26.988(1.0625)	25.400 (1)
15.875 (5/8)	CRY 32 VR	CRY 32 VUUR	476	15.875 (5/8)	50.800 (2)	33.338(1.3125)	31.750 (1 1/4)
	CRY 36 VR	CRY 36 VUUR	599	15.875 (5/8)	57.150 (2 1/4)	33.338(1.3125)	31.750 (1 1/4)
19.050 (3/4)	CRY 40 VR	CRY 40 VUUR	816	19.050 (3/4)	63.500 (2 1/2)	39.688(1.5625)	38.100 (1 1/2)
	CRY 44 VR	CRY 44 VUUR	1 020	19.050 (3/4)	69.850 (2 3/4)	39.688(1.5625)	38.100 (1 1/2)
25.400 (1)	CRY 48 VR	CRY 48 VUUR	1 410	25.400 (1)	76.200 (3)	46.038(1.8125)	44.450 (1 3/4)
	CRY 52 VR	CRY 52 VUUR	1 640	25.400 (1)	82.550 (3 1/4)	46.038(1.8125)	44.450 (1 3/4)
28.575 (1 1/8)	CRY 56 VR	CRY 56 VUUR	2 250	28.575 (1 1/8)	88.900 (3 1/2)	52.388(2.0625)	50.800 (2)
31.750 (1 1/4)	CRY 64 VR	CRY 64 VUUR	3 200	31.750 (1 1/4)	101.600 (4)	58.738(2.3125)	57.150 (2 1/4)

Remarks1. The inner ring has an oil groove and an oil hole.
2. Provided with prepacked grease.

a	R	Shaft dia. mm						Basic dynamic load rating C N	Basic static load rating C ₀ N
		Push fit		Drive fit		Press fit			
		Min.	Max.	Min.	Max.	Min.	Max.		
14.4(0.567)	250 (10)	6.332	6.342	6.348	6.358	6.353	6.363	8 710	12 300
14.4(0.567)	250 (10)	6.332	6.342	6.348	6.358	6.353	6.363	8 710	12 300
19.6(0.772)	300 (12)	7.920	7.930	7.935	7.945	7.940	7.950	13 100	22 700
19.6(0.772)	300 (12)	7.920	7.930	7.935	7.945	7.940	7.950	13 100	22 700
25.0(0.984)	360 (14)	9.507	9.517	9.523	9.533	9.528	9.538	23 600	31 700
25.0(0.984)	360 (14)	9.507	9.517	9.523	9.533	9.528	9.538	23 600	31 700
28.8(1.134)	500 (20)	11.095	11.105	11.110	11.120	11.115	11.125	28 200	40 100
28.8(1.134)	500 (20)	11.095	11.105	11.110	11.120	11.115	11.125	28 200	40 100
32.7(1.287)	500 (20)	12.682	12.692	12.698	12.708	12.708	12.718	35 300	55 600
32.7(1.287)	500 (20)	12.682	12.692	12.698	12.708	12.708	12.718	35 300	55 600
36.0(1.417)	600 (24)	15.857	15.867	15.873	15.883	15.883	15.893	45 700	80 600
36.0(1.417)	600 (24)	15.857	15.867	15.873	15.883	15.883	15.893	45 700	80 600
43.3(1.705)	760 (30)	19.032	19.042	19.048	19.058	19.058	19.068	61 400	116 000
43.3(1.705)	760 (30)	19.032	19.042	19.048	19.058	19.058	19.068	61 400	116 000
54.0(2.125)	760 (30)	25.377	25.390	25.397	25.410	25.408	25.420	77 600	172 000
54.0(2.125)	760 (30)	25.377	25.390	25.397	25.410	25.408	25.420	77 600	172 000
61.9(2.437)	760 (30)	28.522	28.565	28.572	28.585	28.583	28.595	111 000	239 000
71.0(2.797)	760 (30)	31.727	31.740	31.747	31.760	31.758	31.770	142 000	317 000

I
NAST
NURT
CRY

ROLLER FOLLOWERS

Non-separable Roller Followers, Inch Series **Full Complement Type /With Inner Ring**

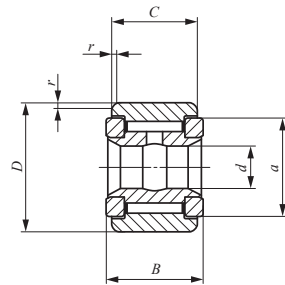

CRY...V

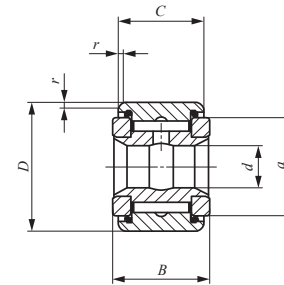

CRY...VUU

Shaft dia. 6.350 – 31.750mm

Shaft dia. mm (inch)	Identification number		Mass (Ref.) g	Boundary dimensions mm(inch)			
	Shield type Cylindrical outer ring	Sealed type Cylindrical outer ring		d	D	B	C
6.350 (1/4)	CRY 12 V	CRY 12 VUU	27	6.350 (1/4)	19.050 (3/4)	14.288(0.5625)	12.700 (1/2)
	CRY 14 V	CRY 14 VUU	36	6.350 (1/4)	22.225 (7/8)	14.288(0.5625)	12.700 (1/2)
7.938 (5/16)	CRY 16 V	CRY 16 VUU	68	7.938 (5/16)	25.400 (1)	17.463(0.6875)	15.875 (5/8)
	CRY 18 V	CRY 18 VUU	77	7.938 (5/16)	28.575 (1 1/8)	17.463(0.6875)	15.875 (5/8)
9.525 (3/8)	CRY 20 V	CRY 20 VUU	109	9.525 (3/8)	31.750 (1 1/4)	20.638(0.8125)	19.050 (3/4)
	CRY 22 V	CRY 22 VUU	136	9.525 (3/8)	34.925 (1 3/8)	20.638(0.8125)	19.050 (3/4)
11.112 (7/16)	CRY 24 V	CRY 24 VUU	186	11.112 (7/16)	38.100 (1 1/2)	23.813(0.9375)	22.225 (7/8)
	CRY 26 V	CRY 26 VUU	227	11.112 (7/16)	41.275 (1 5/8)	23.813(0.9375)	22.225 (7/8)
12.700 (1/2)	CRY 28 V	CRY 28 VUU	290	12.700 (1/2)	44.450 (1 3/4)	26.988(1.0625)	25.400 (1)
	CRY 30 V	CRY 30 VUU	363	12.700 (1/2)	47.625 (1 7/8)	26.988(1.0625)	25.400 (1)
15.875 (5/8)	CRY 32 V	CRY 32 VUU	476	15.875 (5/8)	50.800 (2)	33.338(1.3125)	31.750 (1 1/4)
	CRY 36 V	CRY 36 VUU	599	15.875 (5/8)	57.150 (2 1/4)	33.338(1.3125)	31.750 (1 1/4)
19.050 (3/4)	CRY 40 V	CRY 40 VUU	816	19.050 (3/4)	63.500 (2 1/2)	39.688(1.5625)	38.100 (1 1/2)
	CRY 44 V	CRY 44 VUU	1 020	19.050 (3/4)	69.850 (2 3/4)	39.688(1.5625)	38.100 (1 1/2)
25.400 (1)	CRY 48 V	CRY 48 VUU	1 410	25.400 (1)	76.200 (3)	46.038(1.8125)	44.450 (1 3/4)
	CRY 52 V	CRY 52 VUU	1 640	25.400 (1)	82.550 (3 1/4)	46.038(1.8125)	44.450 (1 3/4)
28.575 (1 1/8)	CRY 56 V	CRY 56 VUU	2 250	28.575 (1 1/8)	88.900 (3 1/2)	52.388(2.0625)	50.800 (2)
31.750 (1 1/4)	CRY 64 V	CRY 64 VUU	3 200	31.750 (1 1/4)	101.600 (4)	58.738(2.3125)	57.150 (2 1/4)

Remarks1. The inner ring has an oil groove and an oil hole.
2. Provided with prepacked grease.

a	r	Shaft dia. mm						Basic dynamic load rating C N	Basic static load rating C ₀ N
		Push fit		Drive fit		Press fit			
		Min.	Max.	Min.	Max.	Min.	Max.		
14.4(0.567)	0.794 (1/32)	6.332	6.342	6.348	6.358	6.353	6.363	8 710	12 300
14.4(0.567)	0.794 (1/32)	6.332	6.342	6.348	6.358	6.353	6.363	8 710	12 300
19.6(0.772)	1.191 (3/64)	7.920	7.930	7.935	7.945	7.940	7.950	13 100	22 700
19.6(0.772)	1.588 (1/16)	7.920	7.930	7.935	7.945	7.940	7.950	13 100	22 700
25.0(0.984)	1.588 (1/16)	9.507	9.517	9.523	9.533	9.528	9.538	23 600	31 700
25.0(0.984)	1.588 (1/16)	9.507	9.517	9.523	9.533	9.528	9.538	23 600	31 700
28.8(1.134)	1.588 (1/16)	11.095	11.105	11.110	11.120	11.115	11.125	28 200	40 100
28.8(1.134)	1.588 (1/16)	11.095	11.105	11.110	11.120	11.115	11.125	28 200	40 100
32.7(1.287)	1.588 (1/16)	12.682	12.692	12.698	12.708	12.708	12.718	35 300	55 600
32.7(1.287)	1.588 (1/16)	12.682	12.692	12.698	12.708	12.708	12.718	35 300	55 600
36.0(1.417)	1.588 (1/16)	15.857	15.867	15.873	15.883	15.883	15.893	45 700	80 600
36.0(1.417)	1.588 (1/16)	15.857	15.867	15.873	15.883	15.883	15.893	45 700	80 600
43.3(1.705)	2.381 (3/32)	19.032	19.042	19.048	19.058	19.058	19.068	61 400	116 000
43.3(1.705)	2.381 (3/32)	19.032	19.042	19.048	19.058	19.058	19.068	61 400	116 000
54.0(2.125)	2.381 (3/32)	25.377	25.390	25.397	25.410	25.408	25.420	77 600	172 000
54.0(2.125)	2.381 (3/32)	25.377	25.390	25.397	25.410	25.408	25.420	77 600	172 000
61.9(2.437)	2.381 (3/32)	28.522	28.565	28.572	28.585	28.583	28.595	111 000	239 000
71.0(2.797)	2.381 (3/32)	31.727	31.740	31.747	31.760	31.758	31.770	142 000	317 000

I
NAST
NURT
CRY